



HIGH-PERFORMANCE BIPOLAR PLATES

FEINforming – the cost-effective manufacturing method of highly efficient metallic bipolar plates for fuel cells

FEINforming: progress through precision

FEINforming helps you achieve more – increased efficiency, lower weight, higher power density in fuel-cell stacks, and extremely cost-effective processes for high-volume parts production.

We offer the following:

- ▶ Comprehensive engineering services along the entire value chain
- ▶ Prototype, pre-series, and series production
- ▶ Presses specifically designed for bipolar plate production
- ▶ FEM-optimized tool design

Feintool's FEINforming technology is essential to the fuel cell's future and is our contribution to the transformation towards sustainable electric transportation.

FEINFORMING: INNOVATIVE FUTURE TECHNOLOGY

With decades of experience and technical leadership in the fineblanking and forming industry, Feintool is committed to develop new processes and tooling technologies for our customers' technological advancement in the fuel cell market. Feintool's attention to precision, tolerance minimization and process optimization for cost and quality make us the right development partner for new bipolar plate design.

FEINforming is Feintool's cutting-edge manufacturing process for the production of high-performance metal bipolar plates for fuel cells. In addition to membrane electrode assemblies (MEA), these plates constitute the key component of polymer electrolyte membrane fuel cells (PEM).

Our one-of-a-kind approach consists of simultaneously producing all stack relevant internal and external geometries as well as the flow field of the bipolar plates in an integrated process.

In conclusion, Feintool is providing our customers and partners with access to a highly economical and optimized production process. FEINforming is for fuel-cell drives that are powerful as well as compact for zero-emission electric vehicles or for stationary fuel cells.

BIPOLAR PLATES: THE LOAD-BEARING COMPONENT OF THE FUEL CELL

The quality of the bipolar plate is crucial for the efficiency and power density of the fuel cell.

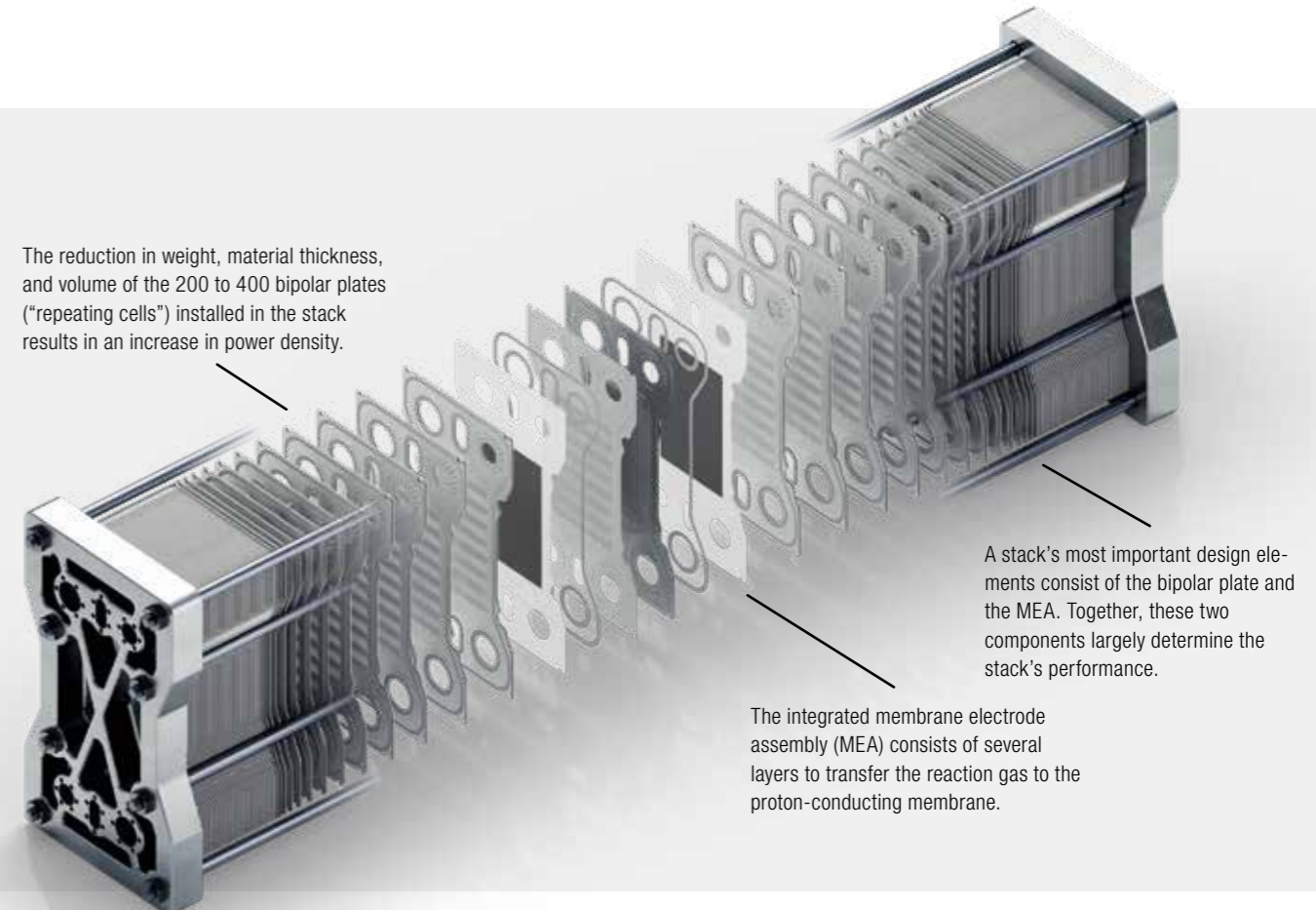
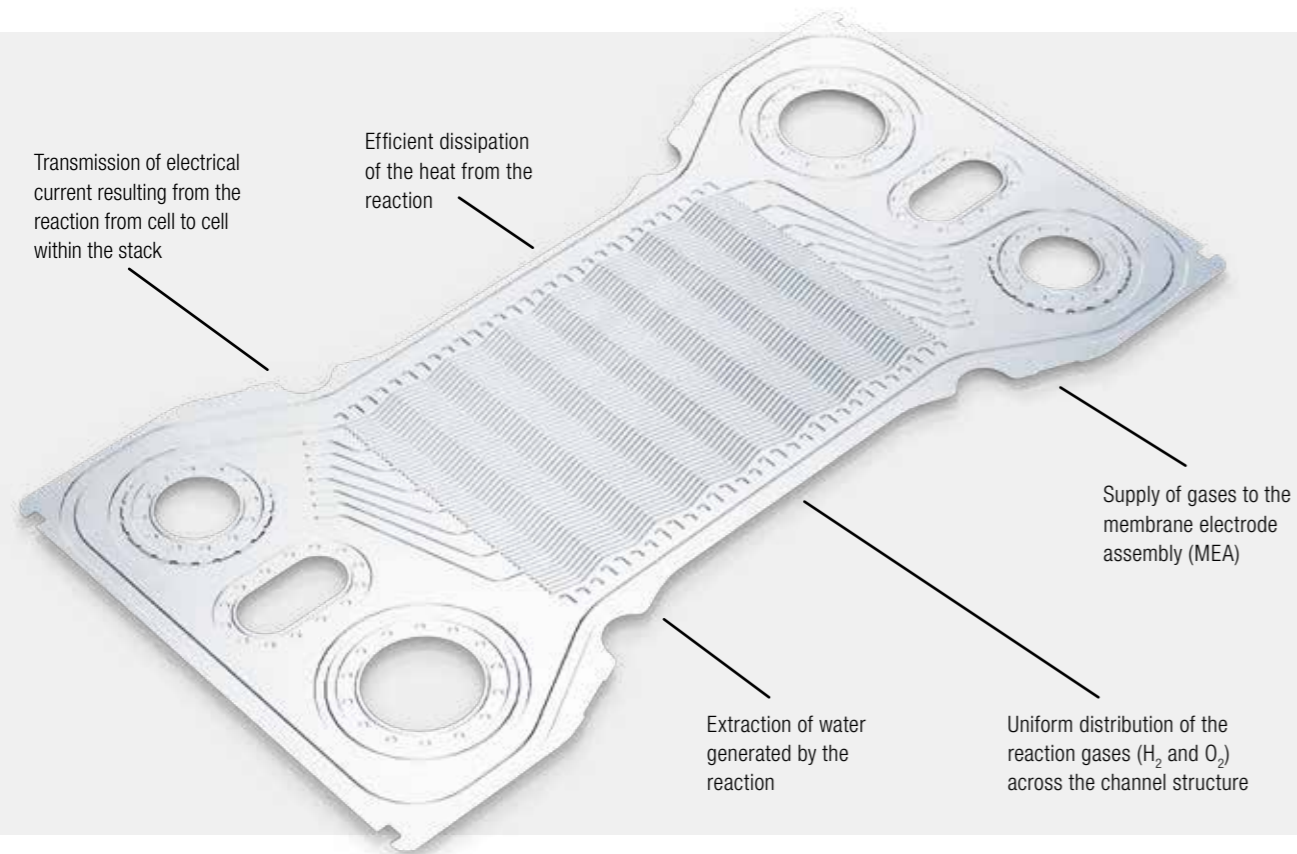

The PEM technology used in vehicles converts hydrogen (H₂) and oxygen (O₂) from the air into water, generating electric power and heat in the process. The bipolar plate is the central component that structurally serves as the carrier plate of a PEM fuel cell. It forms both

poles of the fuel cell – the hydrogen carrying anode plate and the cathode plate for the supplying the oxygen.

The design of the bipolar plates must exhibit perfect gas distribution and optimal electrical conductivity, ensure that water is effectively extracted from the active area, and allow heat to be dissipated efficiently.

PRECISE IMPLEMENTATION OF THE DESIGN REQUIREMENTS

Successful design implementation resulting from extensive engineering expertise.

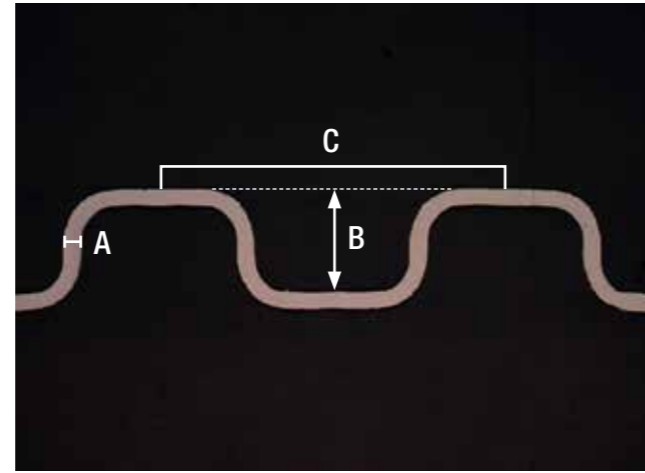

Tool geometry optimization
FEINforming makes it possible to produce dimensionally accurate, true-to-design internal and external geometries when manufacturing metallic bipolar plates.

FEINforming reduces the thinning of the metal plates – as shown in the image on the right.

Flow field of a sample plate
A) Sheet thickness: 0.075 mm
B) Depth of formed channel: 0.45 mm
C) Pitch: 1.5 mm

The perfect interaction of Feintool's latest generation of presses – the FB one – and tools that are optimized step-by-step using a combination of computer simulations and life tooling validation tests with a representative sample size guarantees maximum precision and production efficiency.

- ▶ Continuous homogenous channel height without fluctuations in the resulting material thickness
- ▶ Nearly square channel structures without significantly reducing the cross-section or diameter of radii and a flat surface for the membrane
- ▶ Precisely positioned laser welding reference points to ensure high accuracy throughout subsequent manufacturing processes
- ▶ Simultaneous cutting of inner and outer shapes for maximum precision

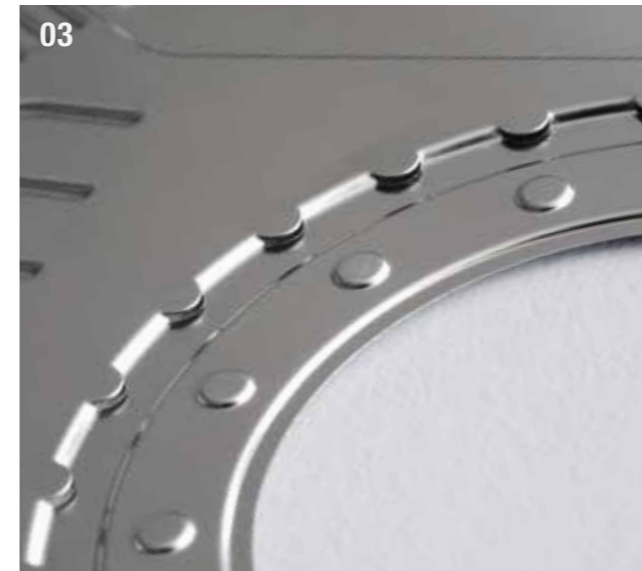
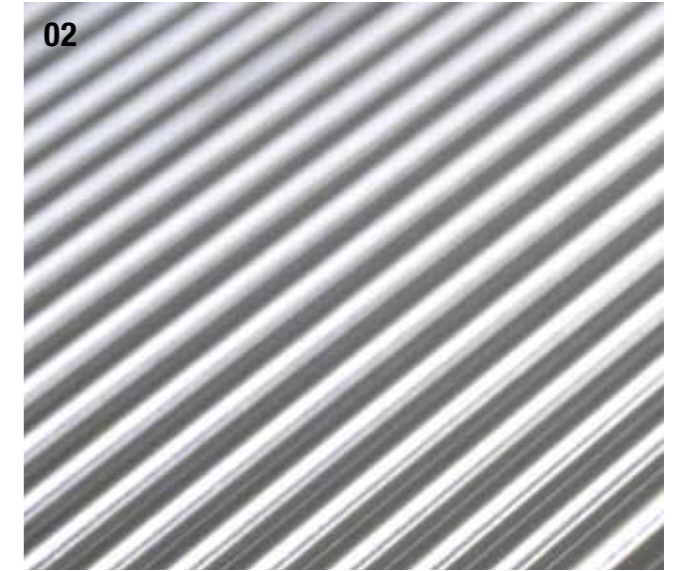
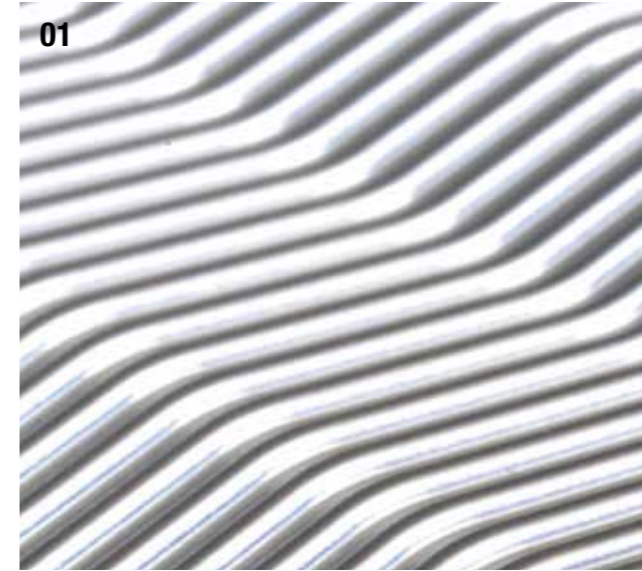

Each bipolar plate consists of several components that are assembled systematically and precisely. Minimizing component tolerances is a key quality factor.

FEINforming is capable of producing every shape of a bipolar plate with outstanding precision.

- ▶ Variety of materials (pre- and uncoated stainless steel, aluminum, titanium)
- ▶ Precise reference points (important for positioning during laser welding)
- ▶ Different channel geometries
- ▶ Cutting inner and outer geometries
- ▶ High-precision, homogeneous channel height
- ▶ Low material thickness

01–04 Structures
Curved channels (01)
Straight channels (02)
Gas flow openings (03)
Special shapes (04)

YOUR KEY TO MORE COST-EFFECTIVE PRODUCTION

Optimizing design implementation, the production process and material usage unlocks cost reduction potential.

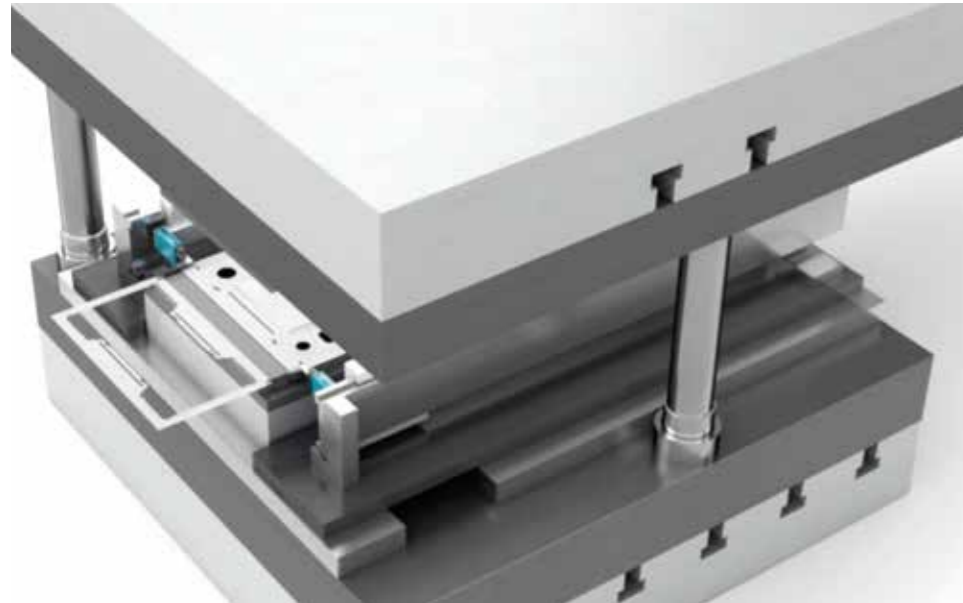

New tool development

FEINforming tools are perfectly compatible with the FB one, which is specially equipped for bipolar plate production.

Production is carried out with automated transfer tools for the anode and cathode. This concept was developed specifically for processing thin sheet metal.

FEINforming: the best-in-class solution

In high-volume series production, FEINforming proves to be the best-in-class solution in four out of five aspects when compared with other production methods.

- FEINforming
- Stamping
- Hydroforming

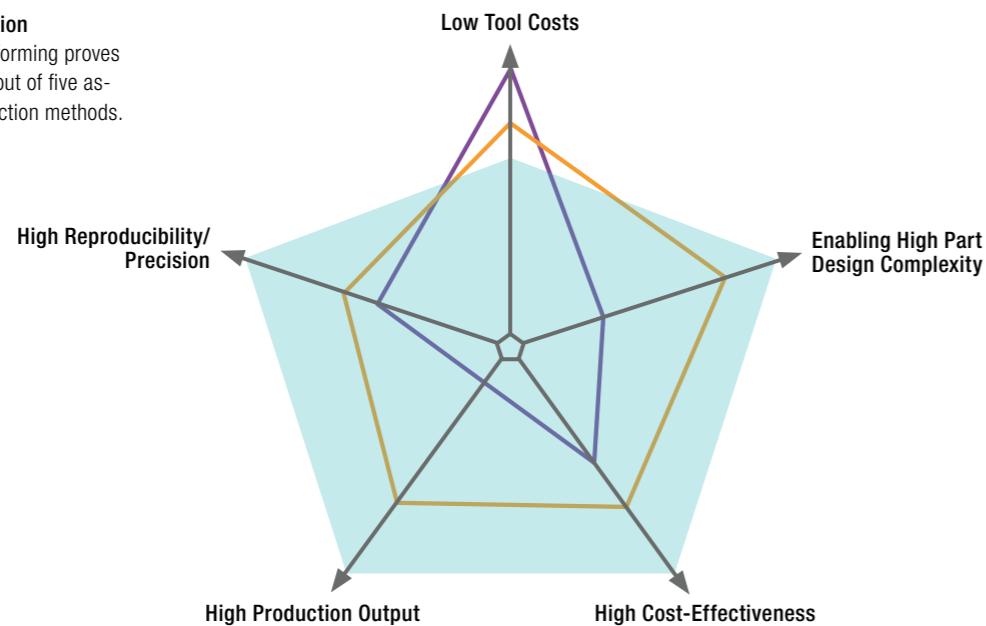

FB ONE: HIGH-END EQUIPMENT FOR SERIES PRODUCTION

This press generation is the ideal solution for manufacturing bipolar plates.

The FB one was designed as a modular fineblanking press combining Feintool's full wealth of knowledge and experience. It embodies Swiss quality in every respect. Flexible tool installation, extreme stiffness, and a compact press size deliver results of unsurpassed accuracy.

The press design features a variety of benefits:

- ▶ A modular design for a number of different applications
- ▶ Installation without a pit
- ▶ Compact exterior design
- ▶ Flexible layout for easy material handling
- ▶ Control system can be integrated into existing networks
- ▶ High capacity with low energy consumption (FEINdrive)

Special advantages of the FB one for bipolar plate production:

- ▶ Modular design allows it to be configured specifically for the production of bipolar plates
- ▶ Dedicated tooling concept
- ▶ Implementation of extremely small radii
- ▶ Minimal component tolerances
- ▶ Specific transfer system for high throughput
- ▶ Reduced number of production steps
- ▶ Perfect interaction of tool and press
- ▶ Outstanding reproducibility
- ▶ Low total investment per part
- ▶ Long tool life



Modular system design



New system layout that is accessible from all sides



Compatibility and flexibility of the tools



Can be expanded in a variety of ways

AN EXTENSIVE RANGE OF CUSTOMER-ORIENTED SERVICES

Feasibility studies, prototype production as well as pre-series and series production.

Feasibility studies: for fast and meaningful results.

Using a simulation process developed in-house by Feintool, we can quickly identify feasible solutions for the predefined target design of a bipolar plate.

- ▶ The initial tool design is based on computer simulation.
- ▶ We use a representative sample to validate the result in a real-world testing process. Any required improvements are carried out afterwards.

During this process, we review and optimize the geometry and avoid costly and time consuming iterations of the production tool.

Prototype and pre-series production: validation and optimization of stack performance.

Prototyping and pre-series production is carried out at Feintool's R&D center in Switzerland. During this important testing phase, we analyze the design of the bipolar plate using a prototype tool before constructing the series production tool. The samples produced on this prototype tooling can then be tested by our customers in their fuel cell stack.

Our methodical approach to testing is conducted under real-world conditions and systematically reveals possible weaknesses in the bipolar plate's design. Our prototyping portfolio also includes welding and coating services.

Our services for you

Feasibility studies	Prototyping	Pre-series production	Series production
<ul style="list-style-type: none"> ▶ Identification of the feasible target geometry ▶ Time-saving virtual simulation procedure ▶ Real-world testing with representative sample geometries 	<ul style="list-style-type: none"> ▶ Validation of technical feasibility and stack performance optimization (at customer's location) ▶ Production volume of up to several hundred plates ▶ Coating and welding (optional) 	<ul style="list-style-type: none"> ▶ Production with automated transfer tool ▶ One tool with change out tooling elements for both anode and cathode production ▶ Use of stamping elements from the prototype tool 	<ul style="list-style-type: none"> ▶ Production with automated transfer tool ▶ Separate tool frame for anode and cathode ▶ Dedicated hydraulic press

BEST-IN-CLASS PRODUCTION IN EUROPE, ASIA, AND NORTH AMERICA

Use the benefits of our global presence for your series production of bipolar plates.

Feintool is your global technology partner for the cost-efficient, high-volume production of precision sheet-metal parts. Our focus is on a customer-driven approach and the resulting flexibility.

Close to the automotive markets

Benefit from our globally connected production facilities located close to the major automotive markets.

Key technology for fuel cells

High-performance bipolar plates increase the power density of fuel-cell stacks. As a result,

they meet one of the basic requirements for producing viable fuel-cell drives in a new performance class.

Innovation for a successful future

Join us in leveraging the future potential of hydrogen-based fuel-cell drive systems for sustainable transportation concepts and stationary fuel-cell concepts.

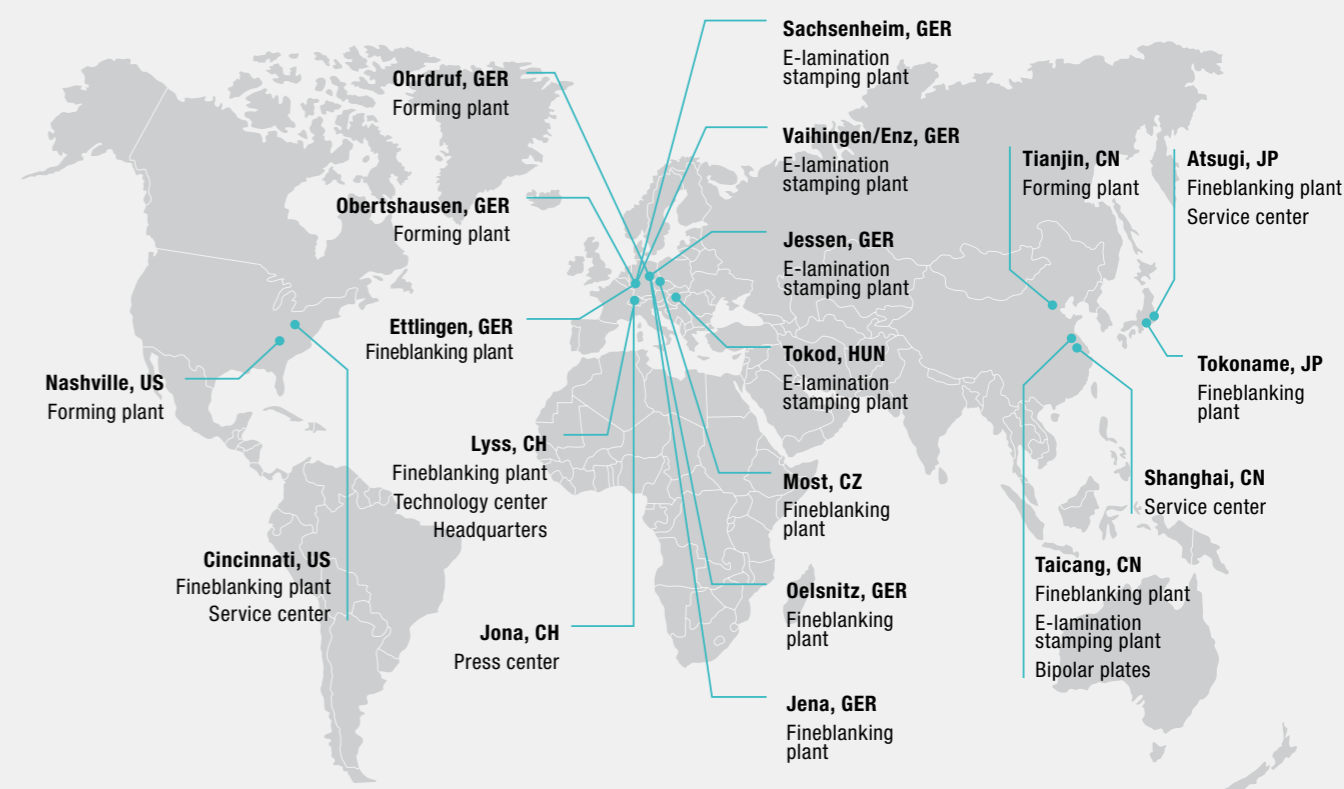

Feintool International Holding AG

Industriering 8
3250 Lyss
Switzerland
+41-32-387-5111
feintool-fih@feintool.com
feintool.com